

# Guías y complementos

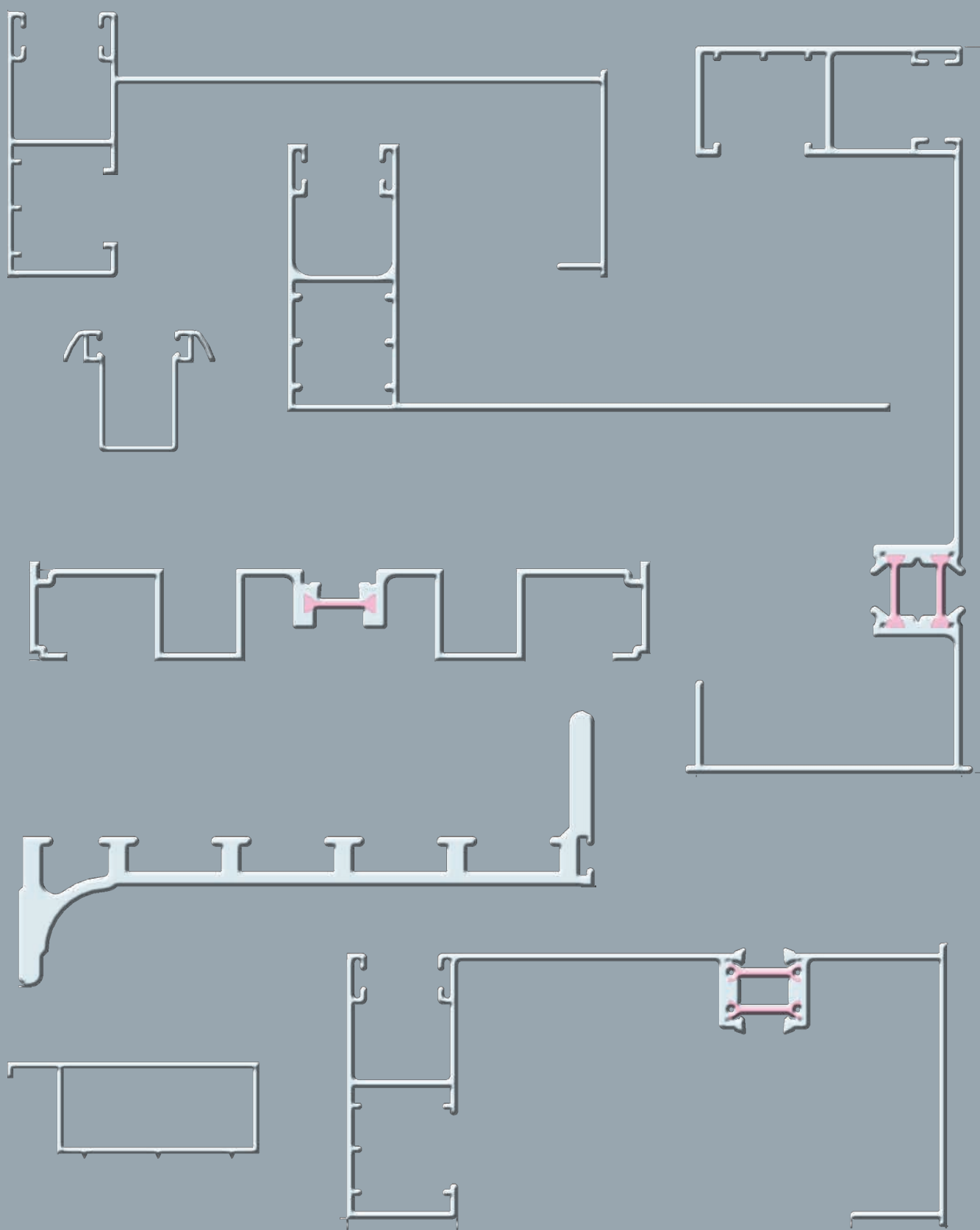

280 Premarco 36

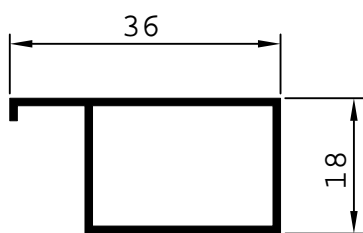

281 Premarco 50

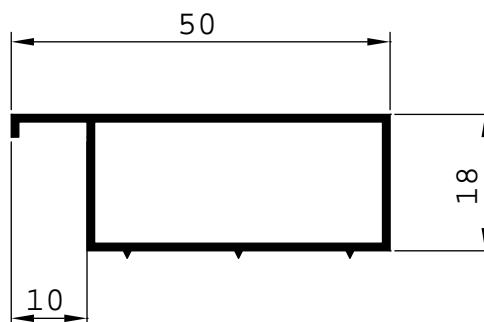

204 Guia

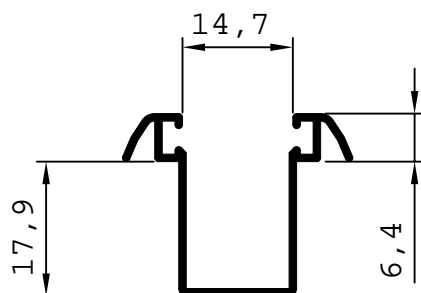

282 Premarco 118,5

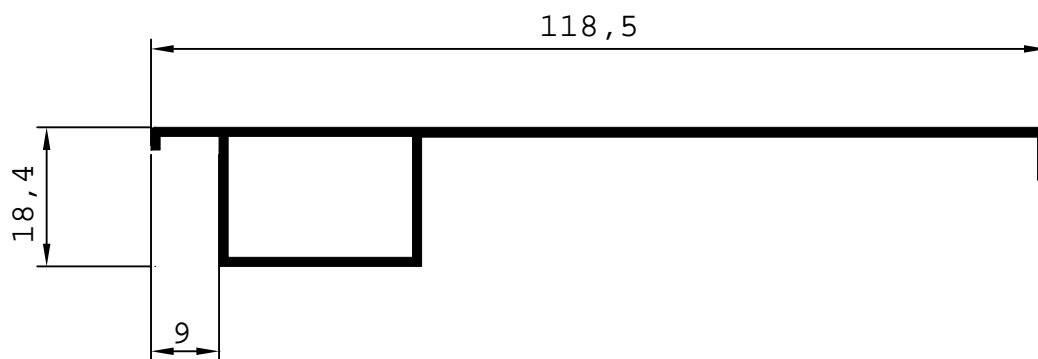

215 Guia compacto 120 mm

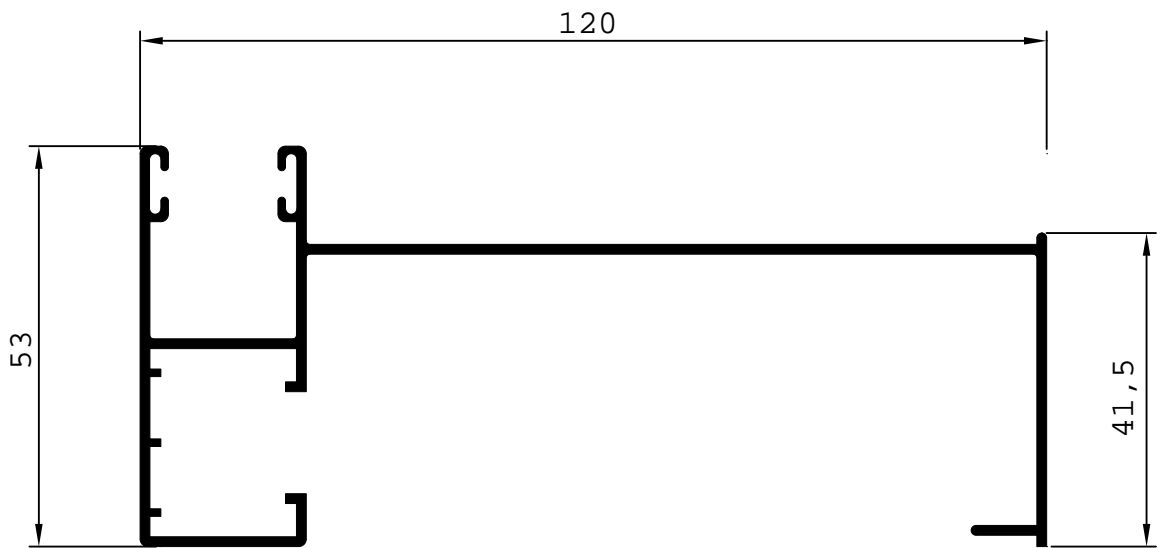

213 Guia

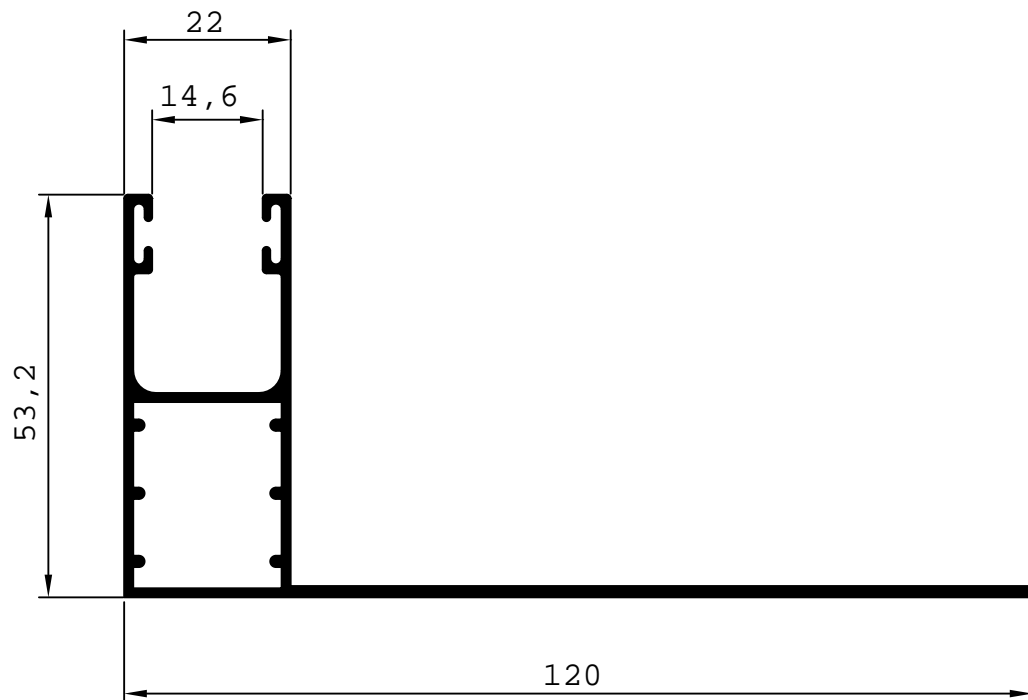

205 Guia 45 mm

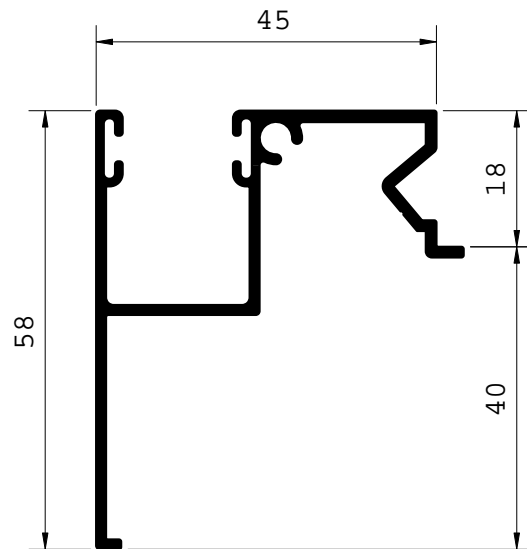

228 Guia 60 mm

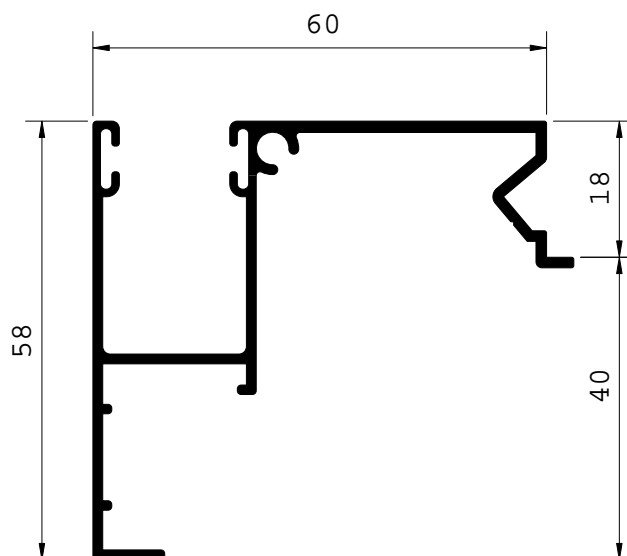

221 Guia 75 mm

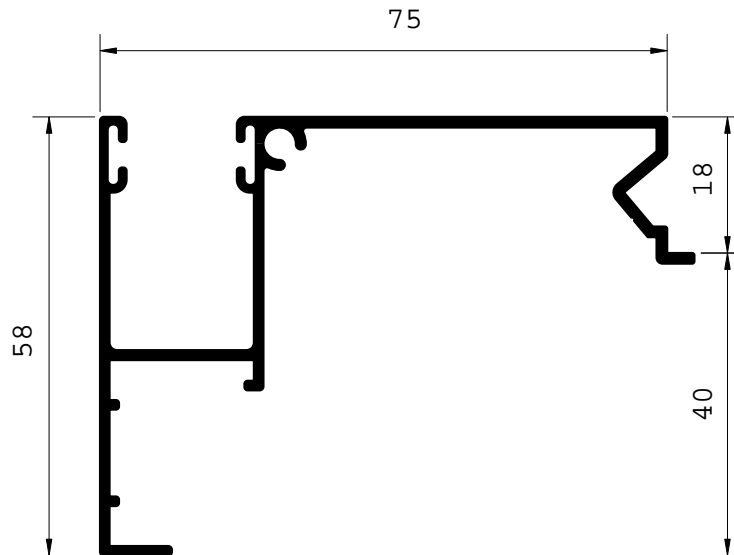

225 Guia 95 mm

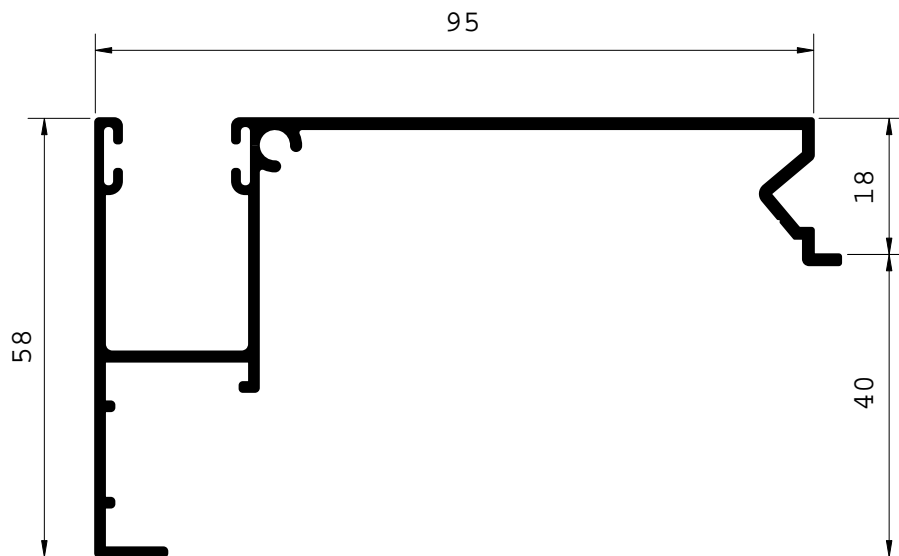

233 Cargadero

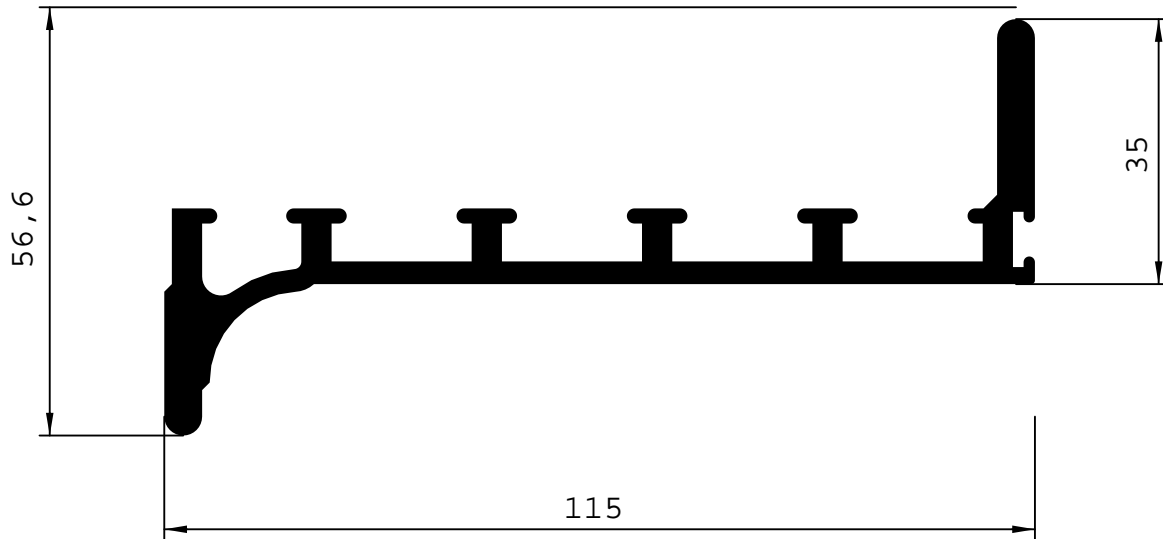

214 Guia compacto 100 mm

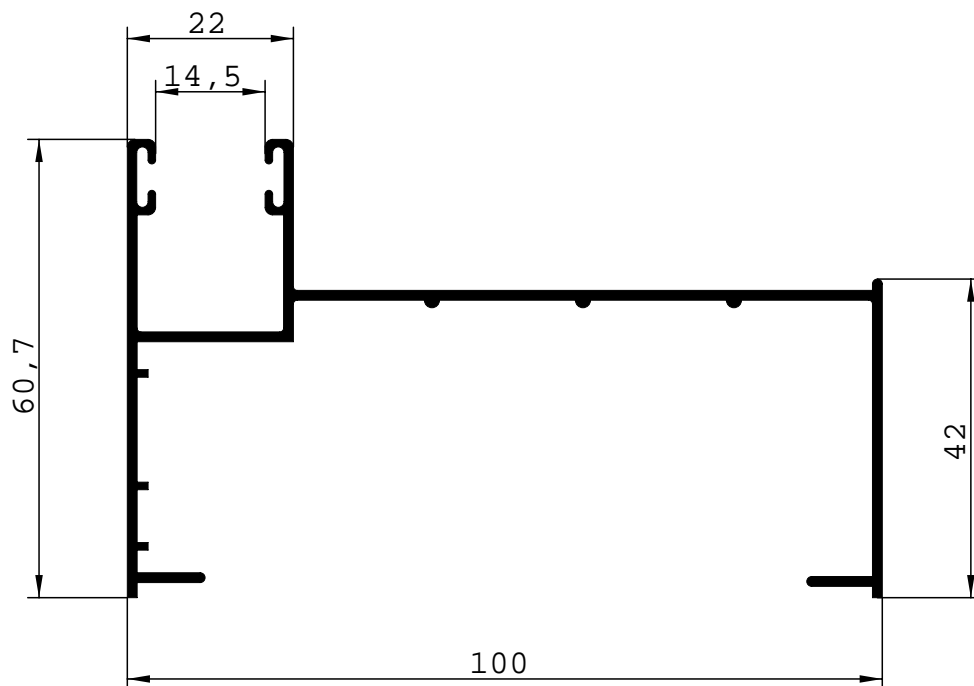

212 Guia doble

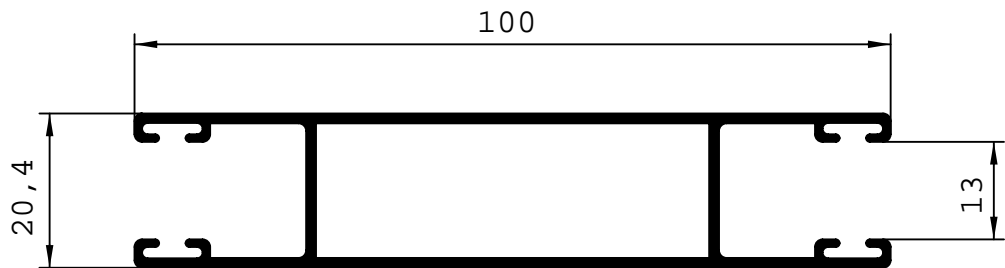

219 Unión guías compacto 120 mm

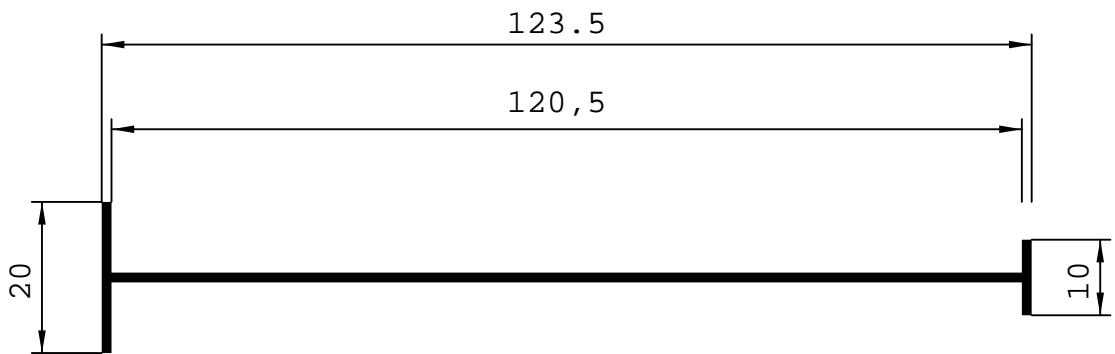

231 Unión guías compacto 120 mm

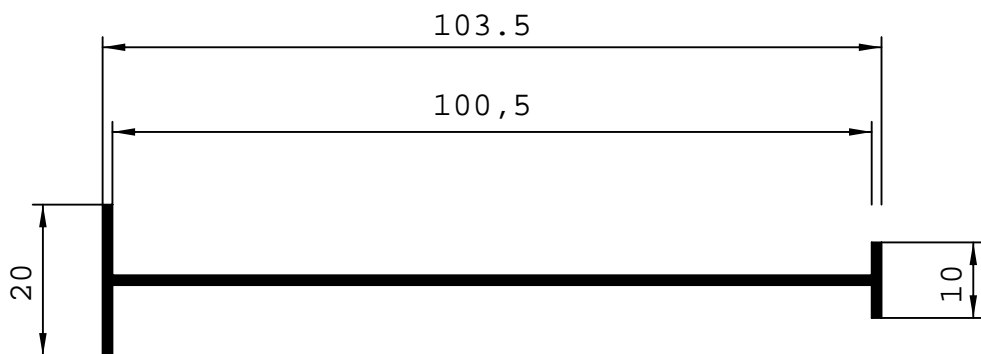

**230 Unión guías compacto 100 mm**

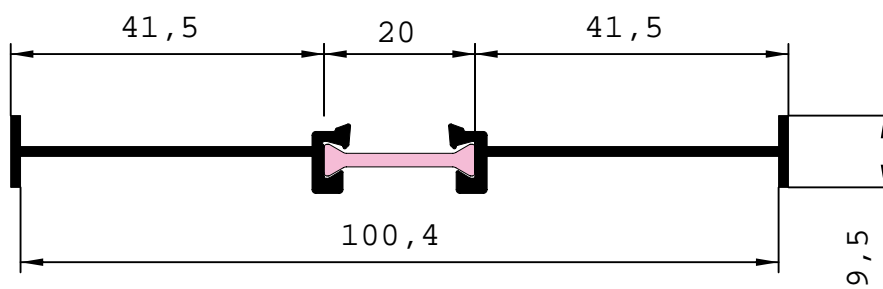

**220 Unión guías compacto 120 mm**

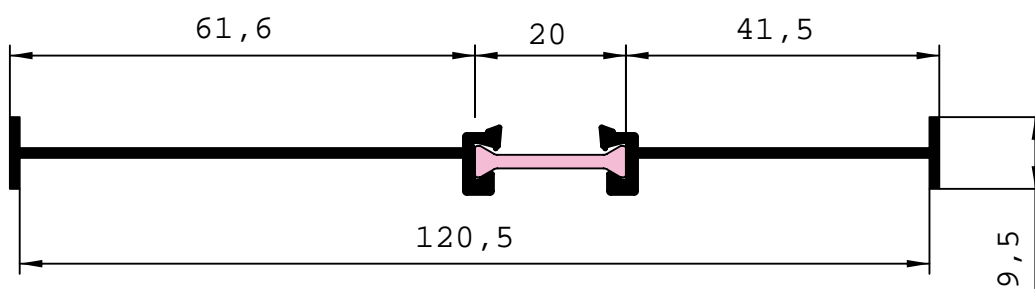



208 Guia compacto 100 mm

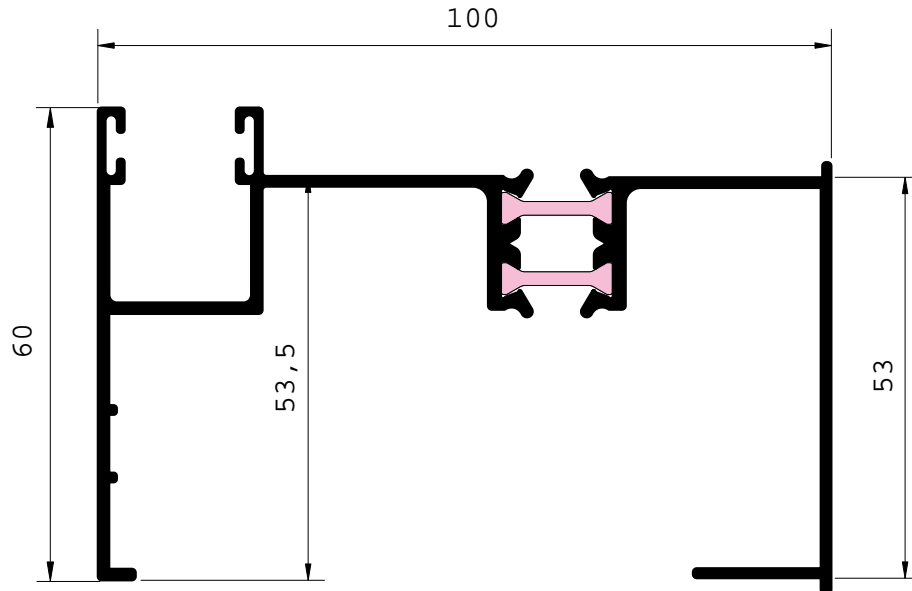

216 Guia compacto 120 mm

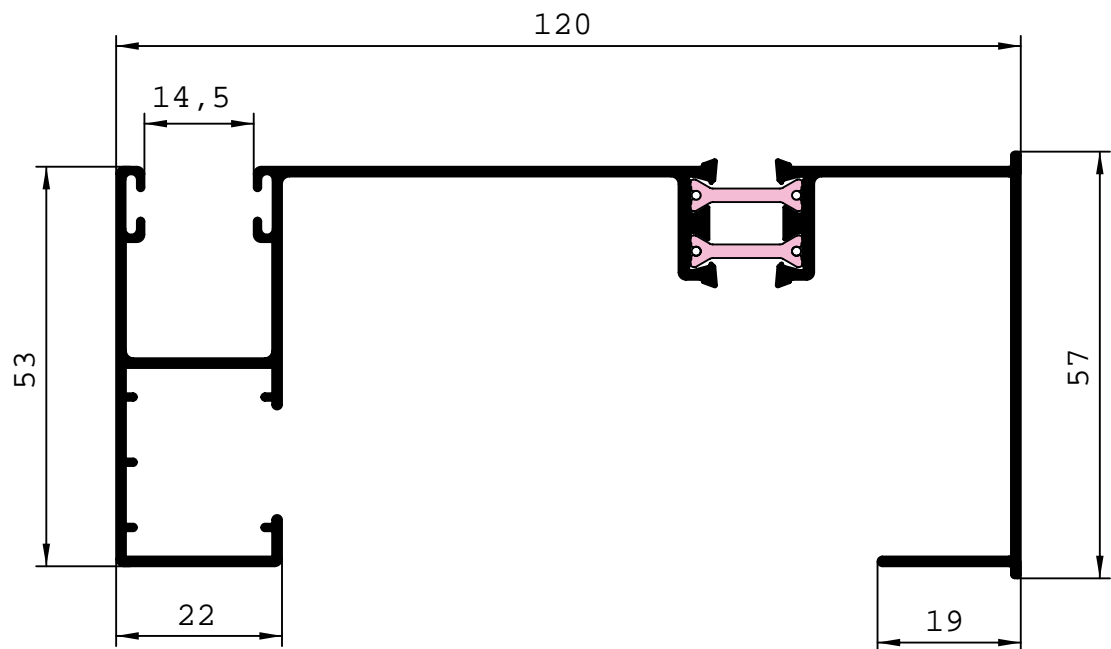

**210 Guia compacto 145 mm**

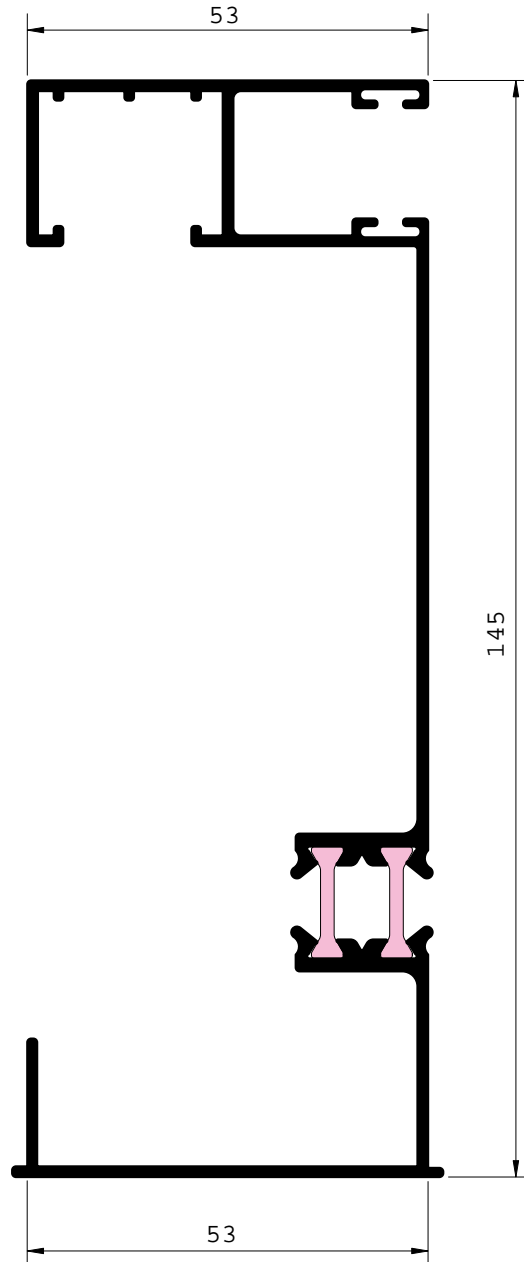

**211 Guia compacto 160 mm**

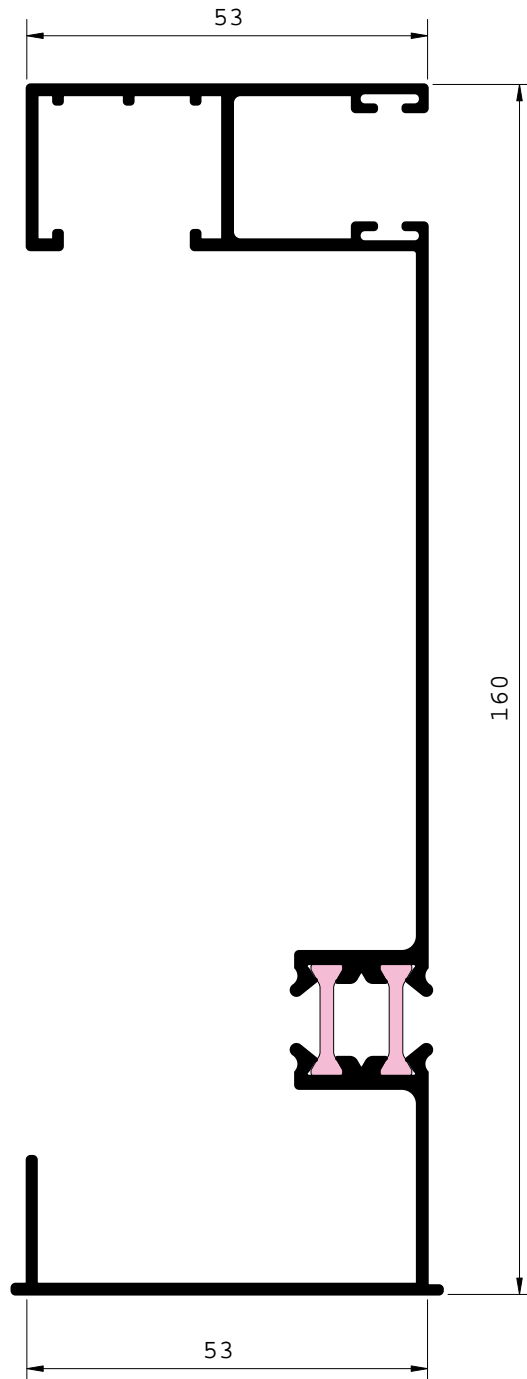

229 Machiembrado

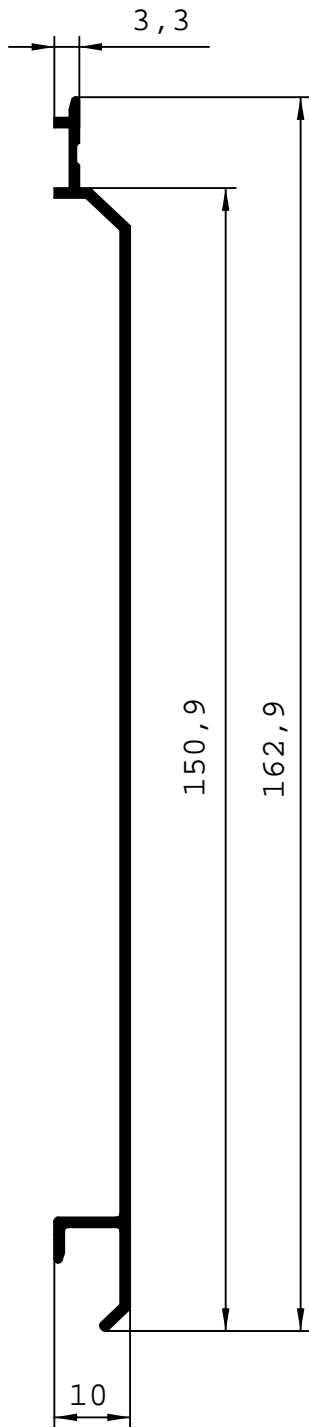

209 Machiembrado

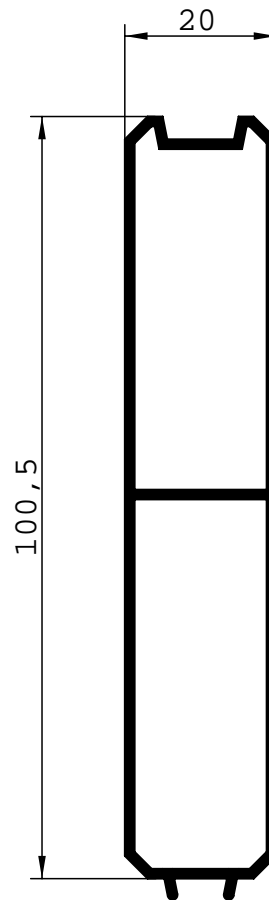

235 Machiembrado

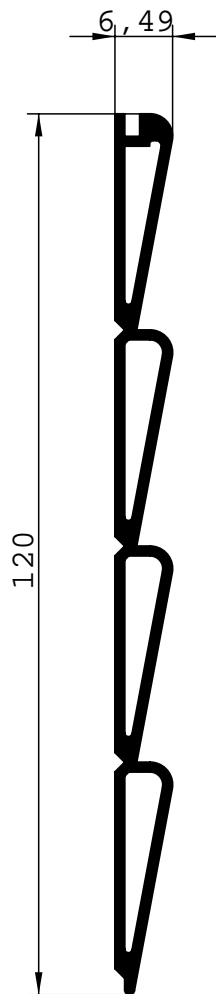

232 Alfeizar

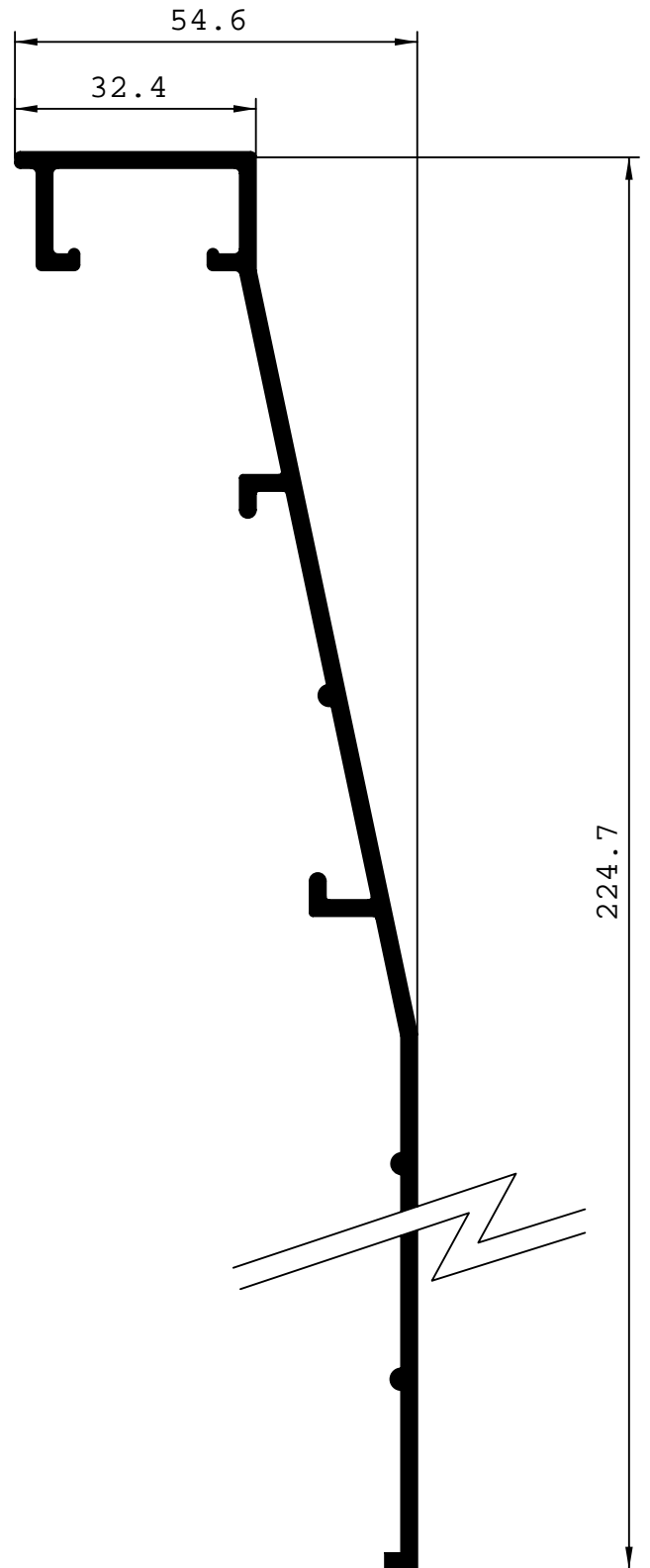

226 Frente cajón persiana

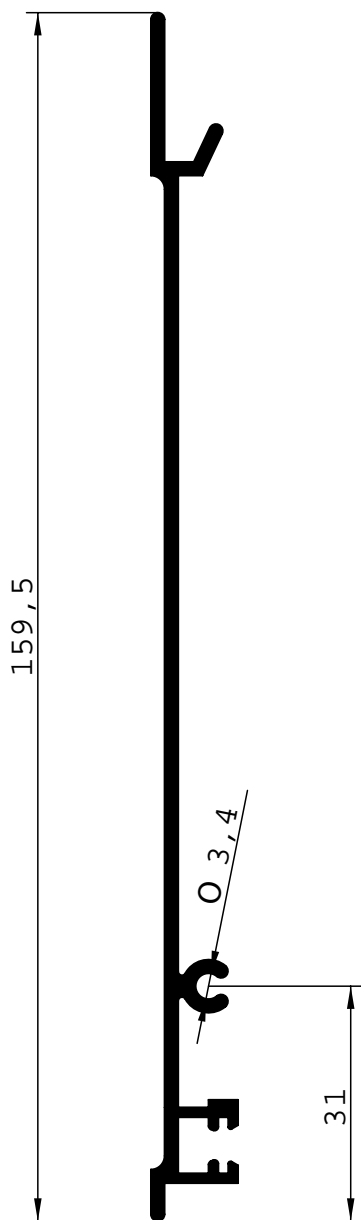

227 Frente cajón persiana

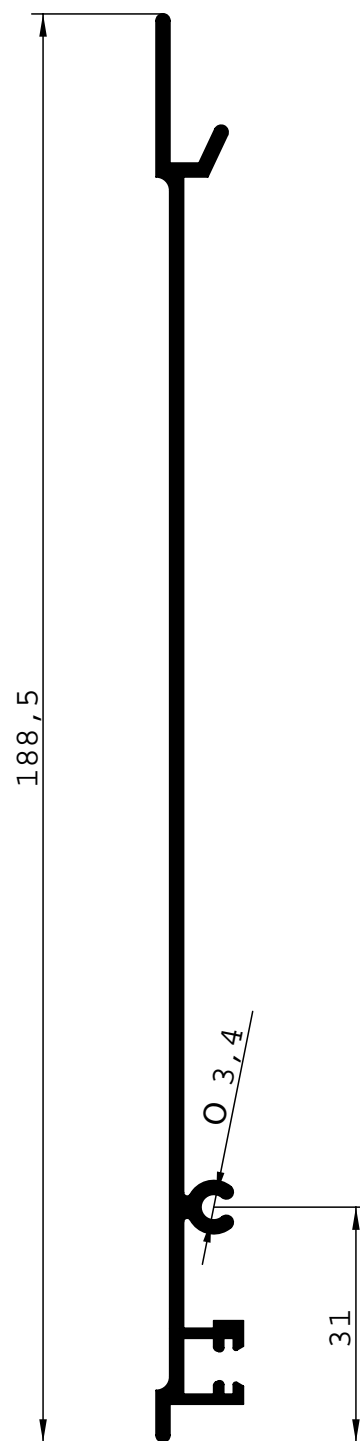

**Esquinero**

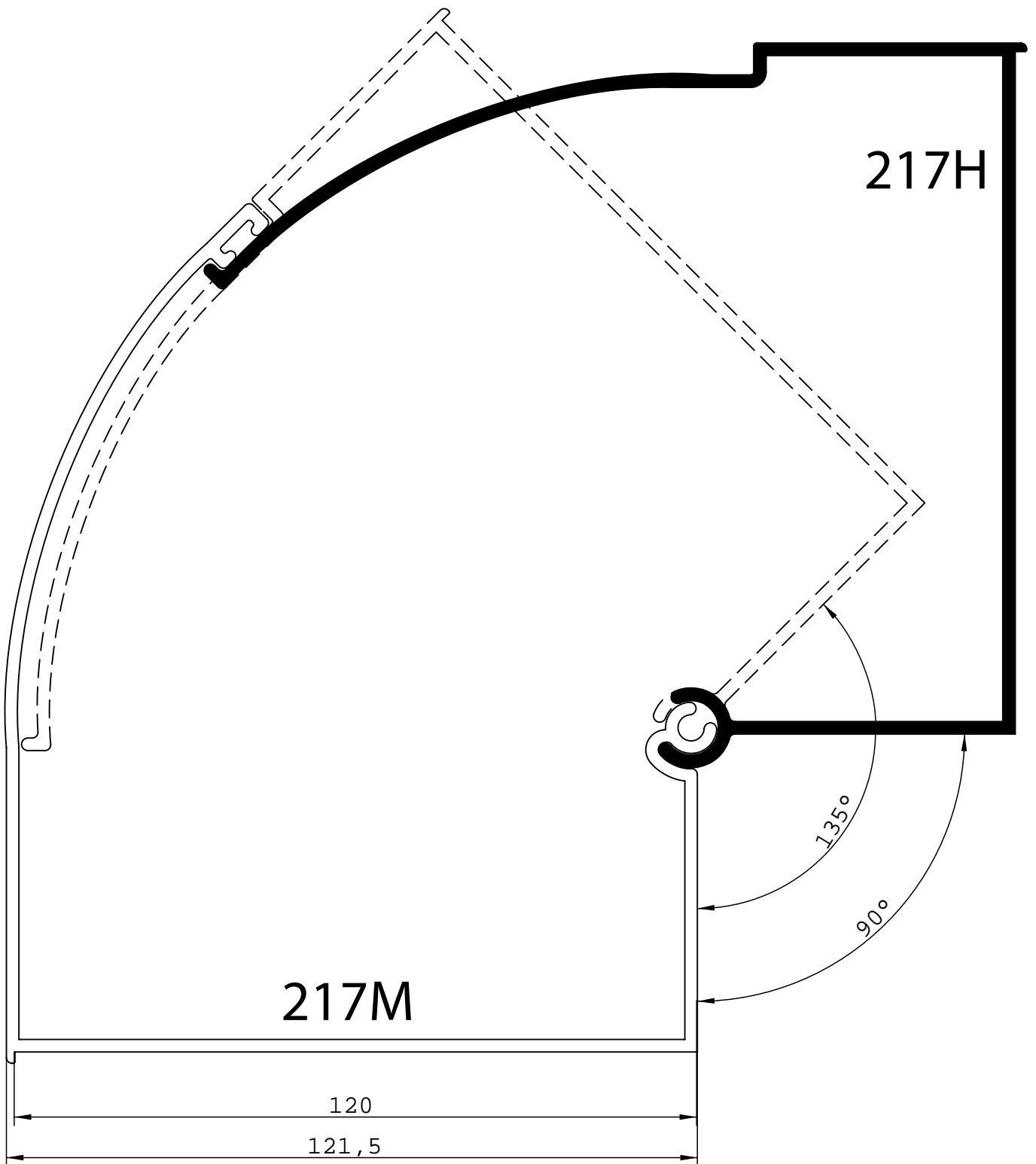

Esquinero compacto RT 120 mm

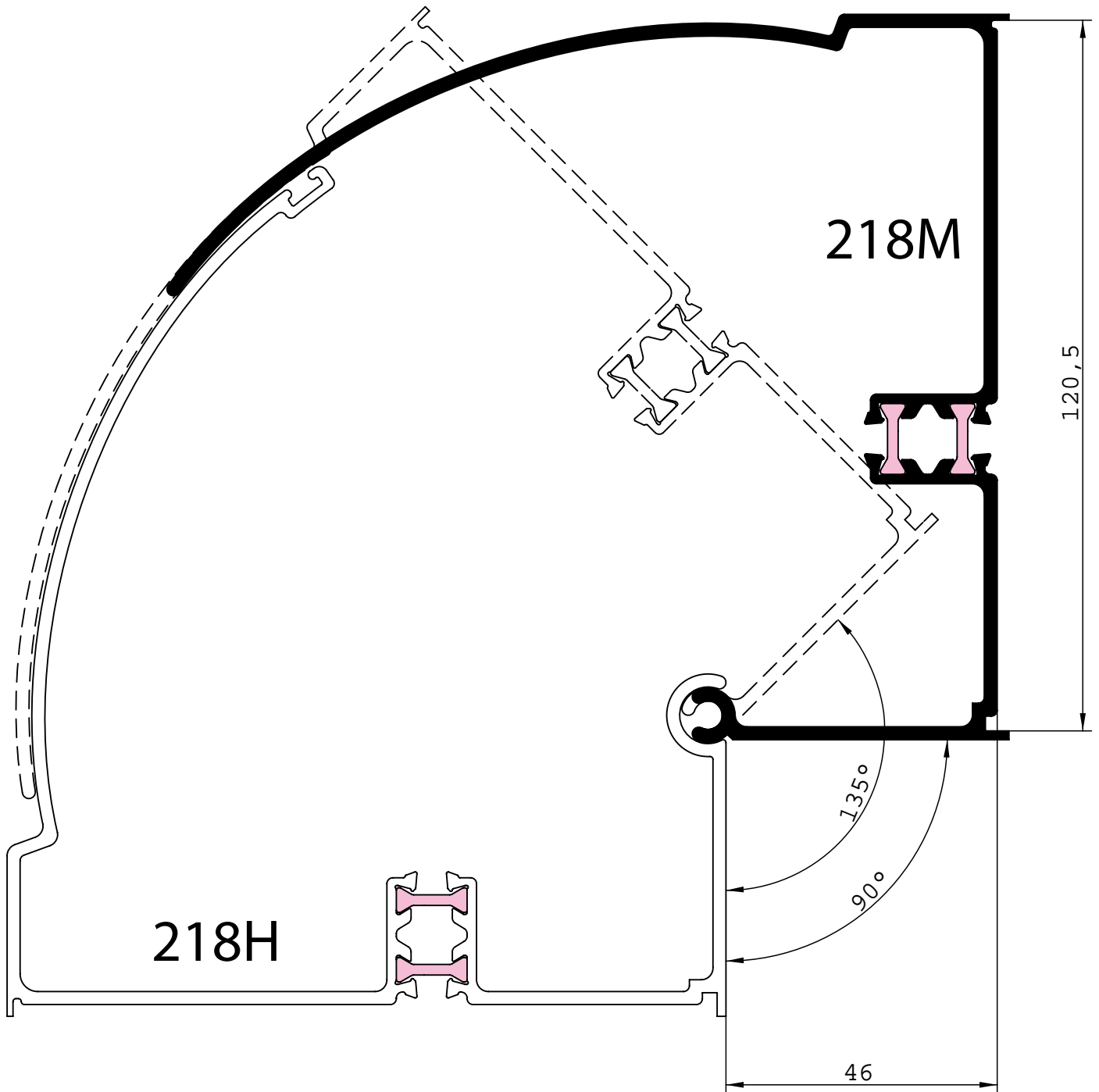



207 Unión compacto RT 120 mm

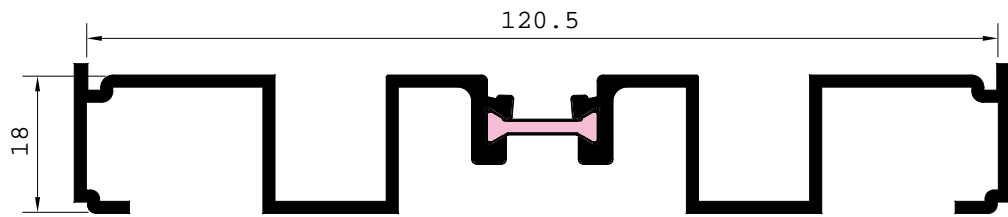

# Mosquitera

240

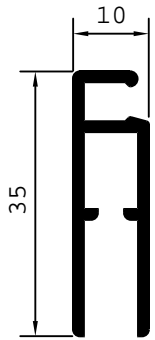

241

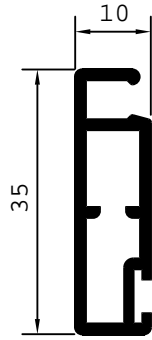

242

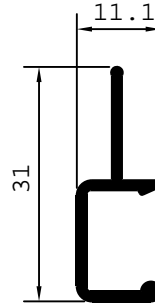

243

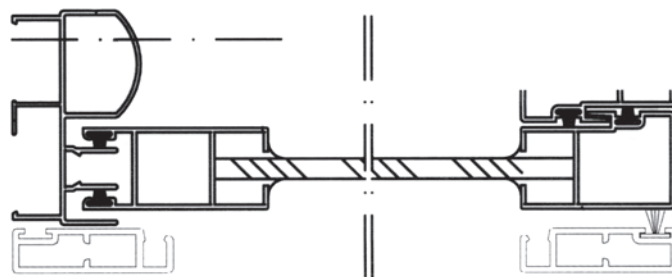
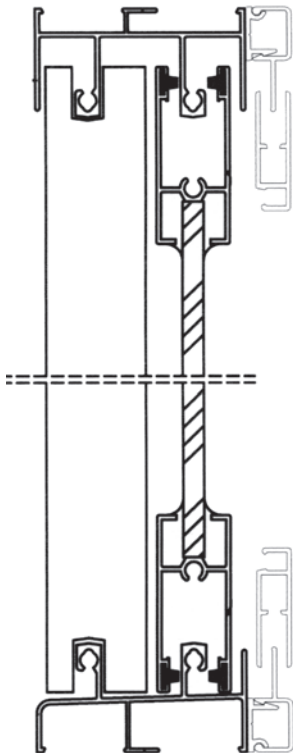
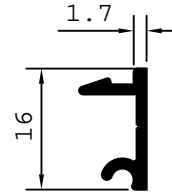

## 222 Acoplamiento compacto

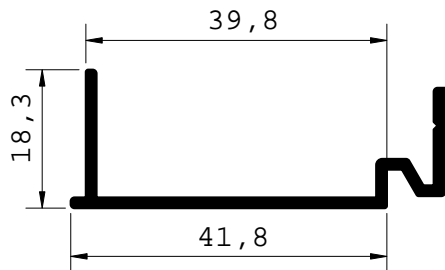

## 224 Acoplamiento compacto

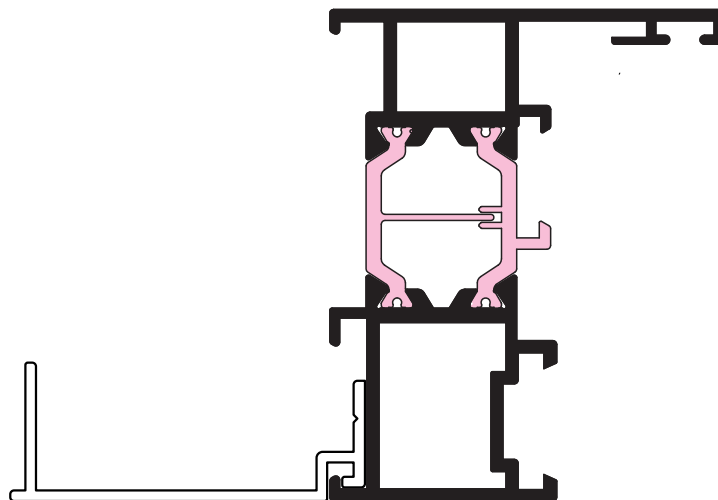
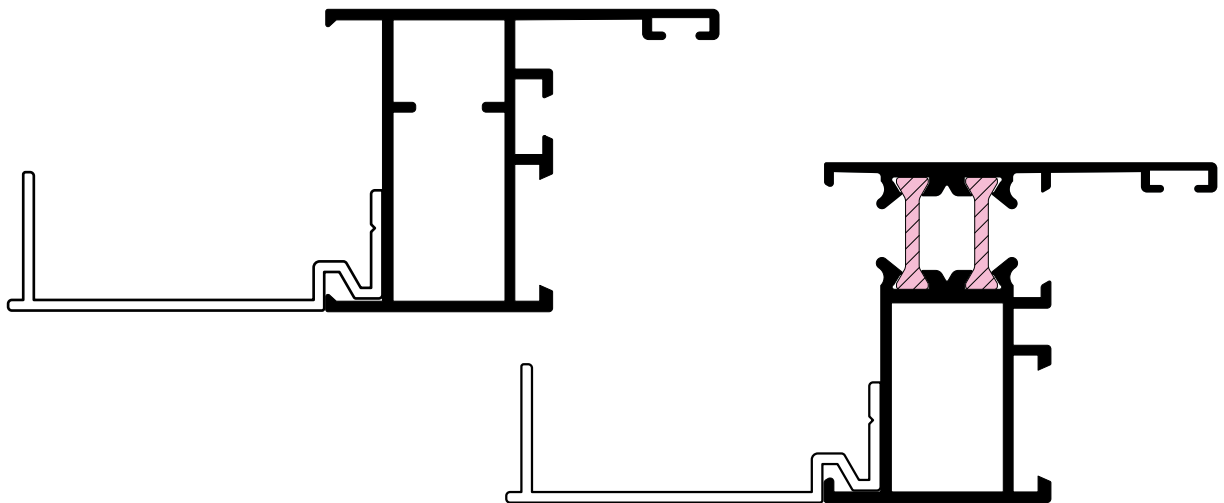
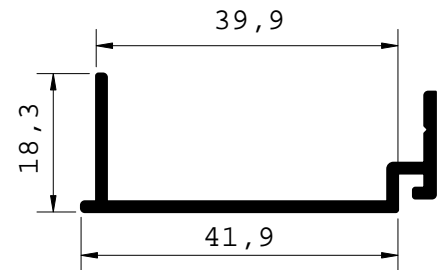

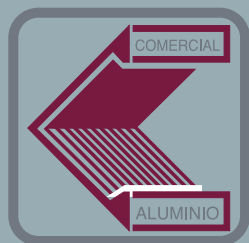

**CODALMHA, S.L.**  
COMERCIAL DEL ALUMINIO

C/ Nogal, 14  
Pol, Ind. Los Huertecillos  
28350 CIEMPOZUELOS (Madrid)

Tel: 918931828

Fax: 918931836